

Parks and gardens lighting

PV solution for urban applications



GIOTTO

GIOTTO



Descrizione prodotto

Il lampione solare Giotto ha un approccio illuminotecnico all-in-one completamente diverso e innovativo grazie al modulo FV verticale e la batteria LiFePO₄ integrati al palo. Giotto si presenta quindi come un oggetto di design ideale per parchi, giardini, zone ciclopedonali, zone di pregio e arredo urbano. Ha una lampada LED circolare con ottica simmetrica e un altoparlante stereo Bluetooth a disposizione degli utenti. È dotato di un sensore IR che, rilevando la presenza di persone in prossimità del lampione, aumenta la luminosità della lampada in modo da migliorare il comfort visivo mantenendo contenuti i consumi energetici.

[eng]

Product description

Giotto solar street lamp has a completely different and innovative all-in-one lighting approach thanks to the vertical PV module and the LiFePO₄ battery integrated into the pole. Giotto therefore presents itself as an ideal design object for parks, gardens, cycle and pedestrian areas, prestigious areas and urban applications. It has a circular LED lamp with symmetrical optics and a Bluetooth stereo speaker available to users. It is equipped with an IR sensor which, by detecting the presence of people near the street lamp, increases the flux of the lamp in order to improve visual comfort while keeping energy consumption low.

[fra]

Product description

Le lampadaire solaire Giotto a une approche d'éclairage "all-in-one" complètement différente et innovatif grâce au module photovoltaïque vertical et à la batterie LiFePO₄ intégrée au mât. Giotto se présente donc comme un objet de design idéal pour les parcs, les jardins, les zones cyclables et piétonnes, les espaces prestigieux et les applications urbaines. Il dispose d'une lampe LED circulaire à optique symétrique et d'un haut-parleur stéréo Bluetooth à la disposition des utilisateurs. Il est équipé d'un capteur IR qui, en détectant la présence de personnes à proximité du lampadaire, augmente la luminosité de la lampe afin d'améliorer le confort visuel tout en maintenant une faible consommation d'énergie.



GIOTTO

Caratteristiche prodotto

- Li** LiFePO₄ battery long life and high performance
- Flux reduction self management to prevent low battery level

[eng] Product features

- Bluetooth speakers
- High efficiency LED lamps

[fra] Caractéristiques du produit

- Installation in gardens, parks, sidewalks, bicycle lanes and parking areas
- Easy to install and maintenance

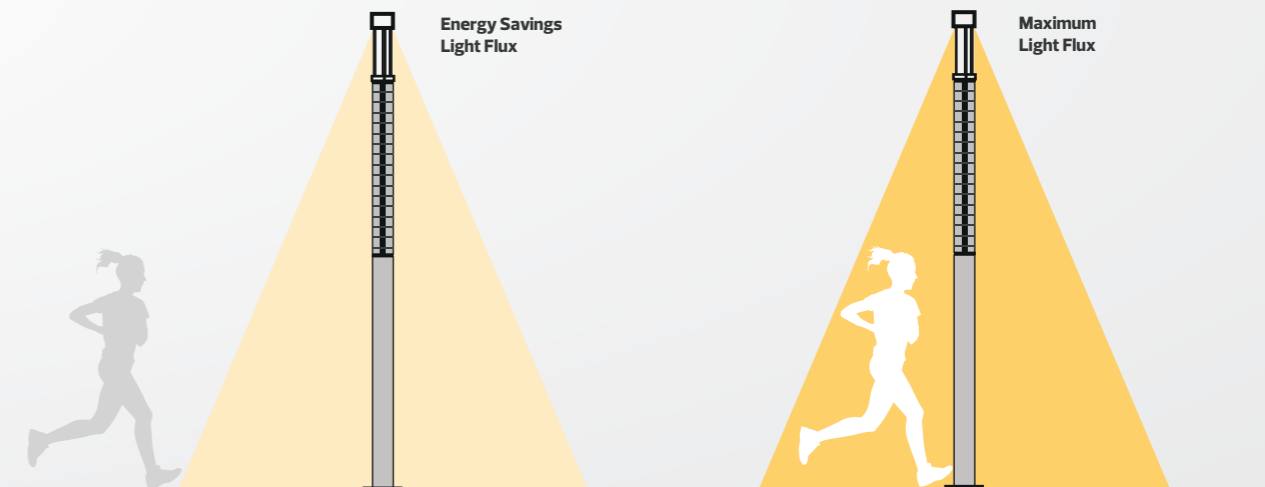
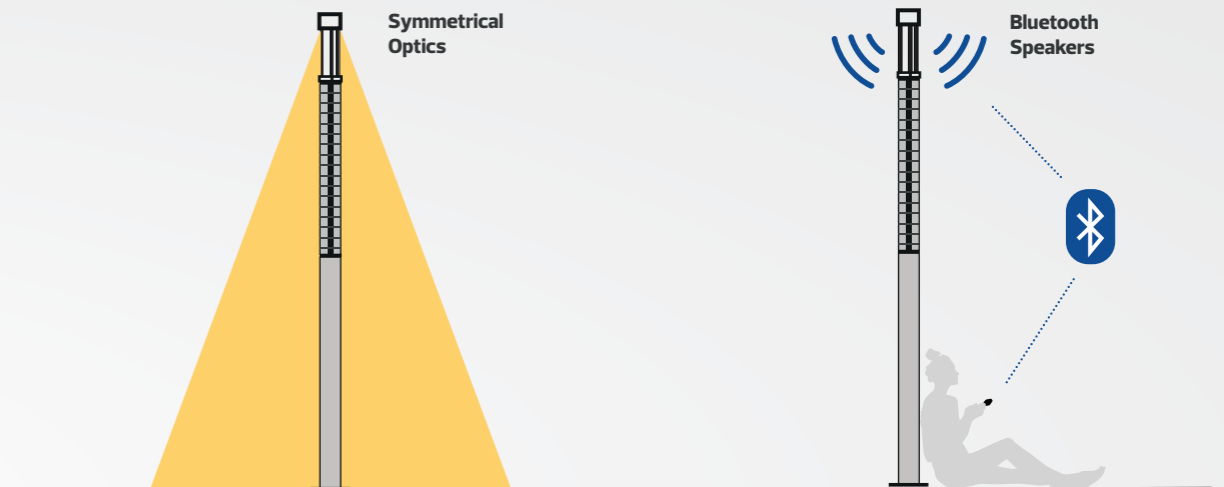

Bluetooth control included as standard

Caratteristiche tecniche

[eng] Technical characteristics

[fra] Caractéristiques techniques

Pv module	240W monocrystalline cylindrical shape
Battery	LiFePO ₄ >3500Cycles (80%DOD) installed inside the pole 12,8V 42Ah
Charge controller*	SPB-20 Bluetooth connection by smartphone or PC. MPPT high efficiency (> 95%)
Street lamp	Integrated lamp power 25W 3100lm
Color temperature – CRI	4000°K – CRI>70
Optic	Symmetric for wide area lighting – gardens and parks PMMA material
Light control	Self-management flux reduction to maximize lamp operation during cloudy days.
Mechanical parts	Pole: 5mt high above the ground, steel made and hot deep galvanized and painted RAL 7043 Wind load resistance in accordance to Eurocode 0-1-3 and production compliant to EN1090-2

*on demand may be supplied **SPB-20/GSM** charge controller with **2G** modem with data monitoring through Western CO. web application (**WCloud**).

Speaker Bluetooth
Bluetooth Speaker
Haut-parleur Bluetooth

Regolatore di carica
Charge Controller
Contrôleur de charge

Modulo FV cristallino
Crystalline PV module
Module PV cristallin

Sensore IR
IR sensor
Capteur IR

Batteria LiFePO₄
LiFePO₄ battery
Batterie LiFePO₄

Palo
Pole
Poteau

Technical scheme

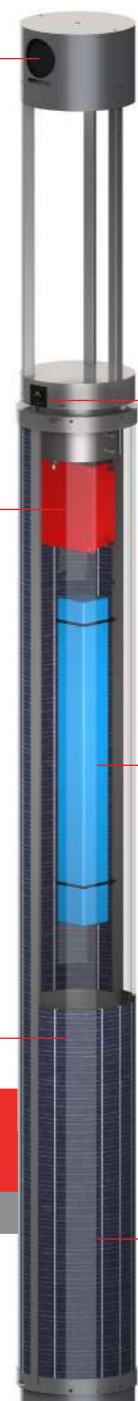

Dimensioni del prodotto

[eng] Product dimensions

[fra] Dimensions du produit

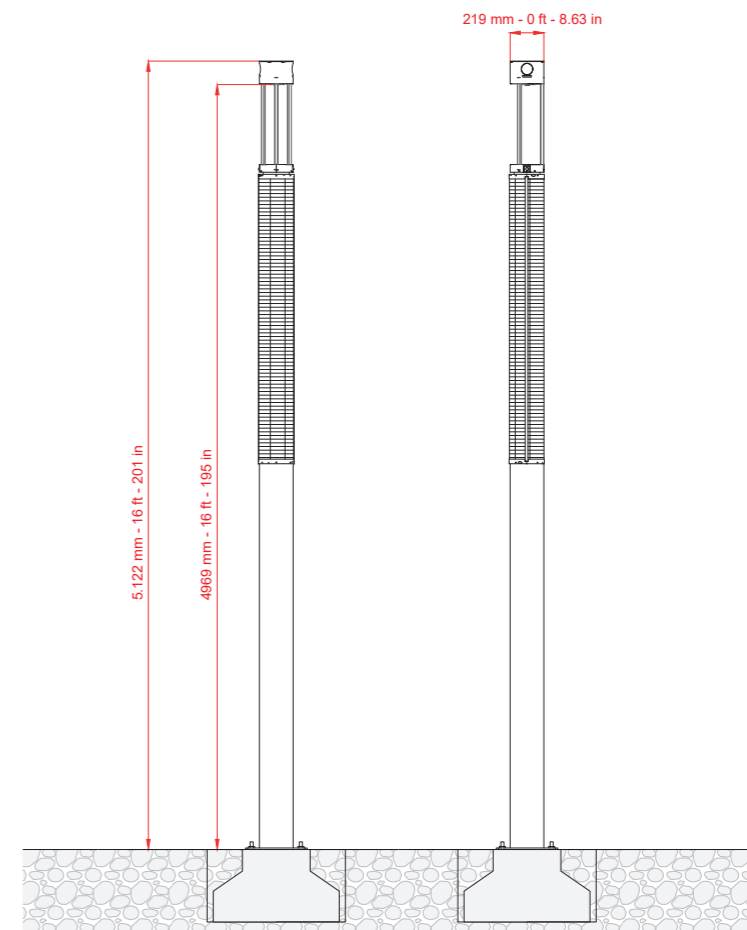

Realizzazioni

[eng] Realizations

[fra] Réalisations

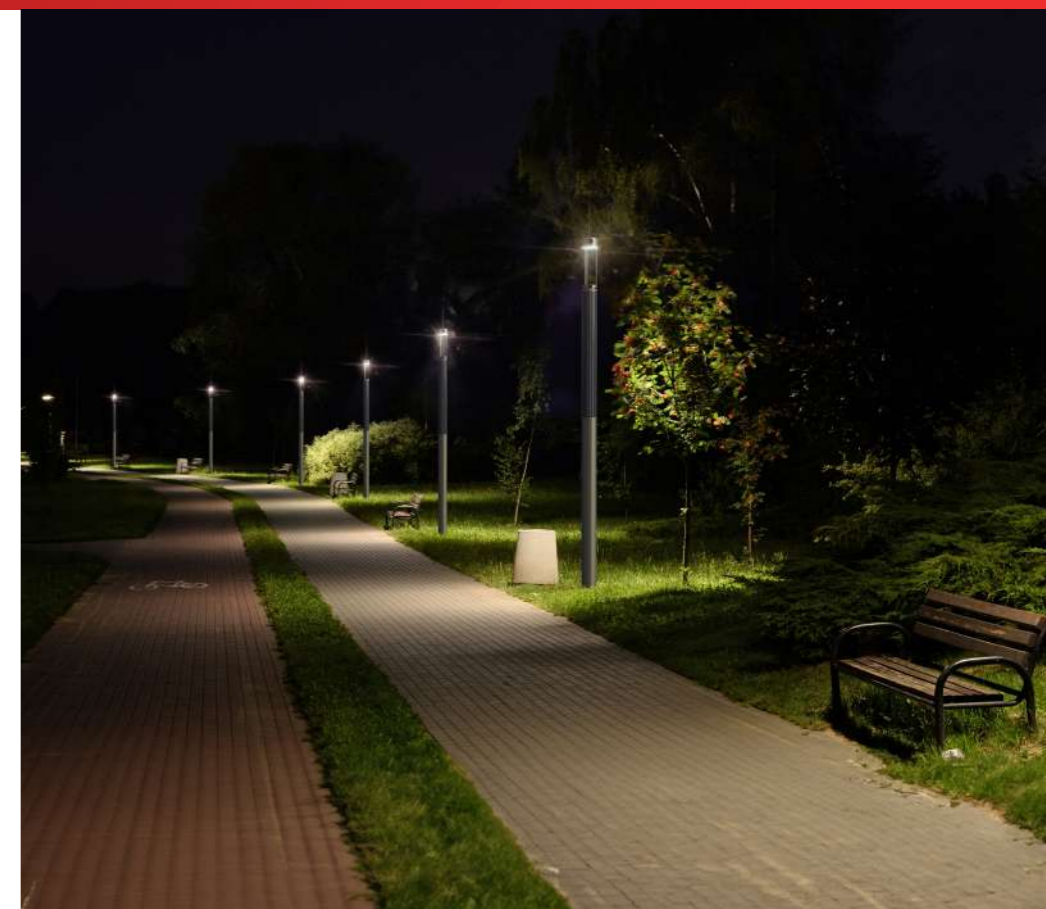

GIOTTO ARM



Descrizione prodotto

Il lampione solare Giotto Arm ha un approccio illuminotecnico all-in-one completamente diverso e innovativo grazie al modulo FV verticale e la batteria LiFePO₄ integrati al palo.

Giotto Arm si presenta quindi come un oggetto di design ideale per parchi, giardini, zone ciclopedonali, zone di pregio e arredo urbano.

Ha una lampada LED e un altoparlante stereo Bluetooth a disposizione degli utenti. È dotato di un sensore IR che, rilevando la presenza di persone in prossimità del lampione, aumenta la luminosità della lampada in modo da migliorare il comfort visivo mantenendo contenuti i consumi energetici.

[eng]

Product description

Giotto Arm solar street lamp has a completely different and innovative all-in-one lighting approach thanks to the vertical PV module and the LiFePO₄ battery integrated into the pole. Giotto Arm therefore presents itself as an ideal design object for parks, gardens, cycle and pedestrian areas, prestigious areas and urban applications.

It has a LED lamp with bracket and a Bluetooth stereo speaker available to users. It is equipped with an IR sensor which, by detecting the presence of people near the street lamp, increases the flux of the lamp in order to improve visual comfort while keeping energy consumption low.

[fra]

Product description

Le lampadaire solaire Giotto Arm a une approche d'éclairage "all-in-one" complètement différente et innovatif grâce au module photovoltaïque vertical et à la batterie LiFePO₄ intégrée au mât. Giotto se présente donc comme un objet de design idéal pour les parcs, les jardins, les zones cyclables et piétonnes, les espaces prestigieux et les applications urbaines. Il dispose d'une lampe LED avec bras et d'un haut-parleur stéréo Bluetooth à la disposition des utilisateurs.

Il est équipé d'un capteur IR qui, en détectant la présence de personnes à proximité du lampadaire, augmente la luminosité de la lampe afin d'améliorer le confort visuel tout en maintenant une faible consommation d'énergie.



GIOTTO ARM

Caratteristiche prodotto

Li LiFePO₄ battery long life and high performance

 Flux reduction self management to prevent low battery level

[eng] Product features

 Bluetooth speakers

 High efficiency LED lamps

[fra] Caractéristiques du produit

 Installation in gardens, parks, sidewalks, bicycle lanes and parking areas

 Easy to install and maintenance

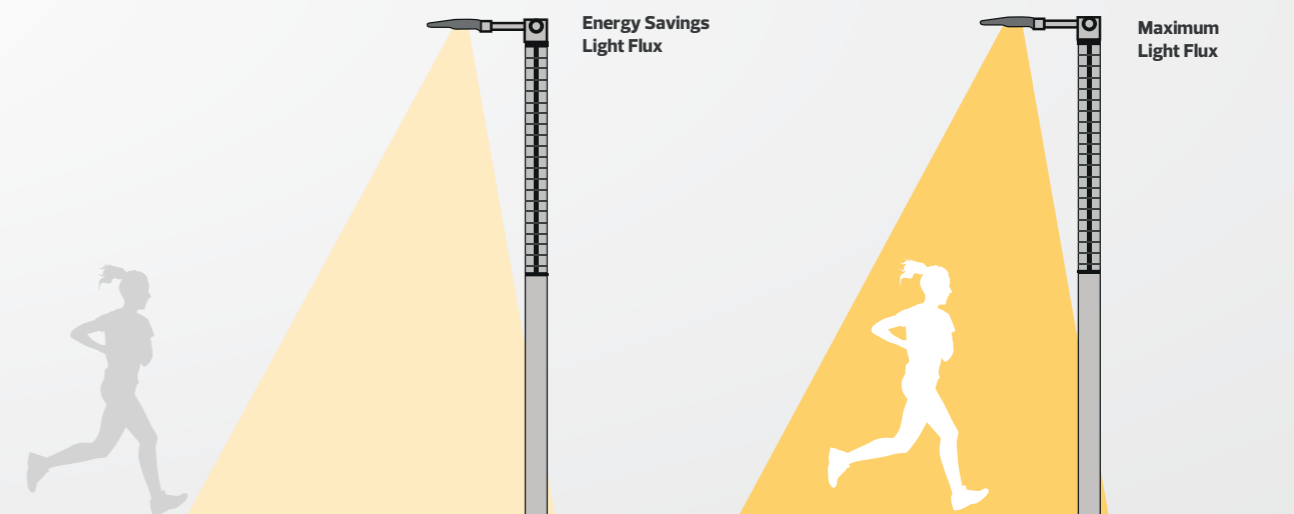
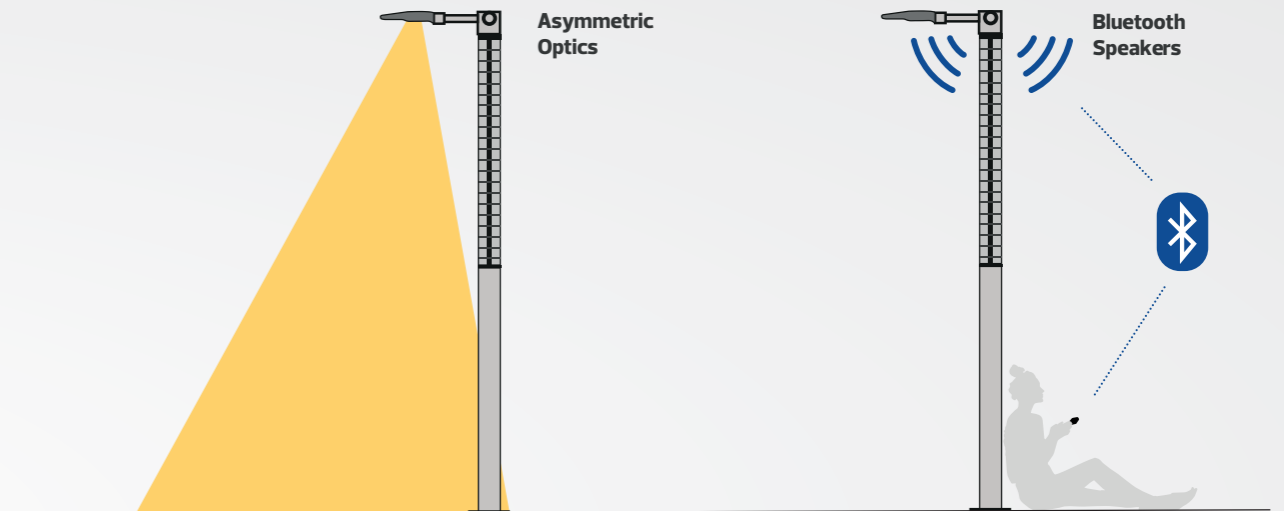

Bluetooth control included as standard

Caratteristiche tecniche

[eng]
Technical characteristics

[fra]
Caractéristiques techniques

Pv module	Giotto Arm with a height of 4.5mt: 240W monocrystalline cylindrical shape
Battery	Giotto Arm with a height of 4.5mt**: LiFePO ₄ >3500Cycles (80%DOD) installed inside the pole - 12,8V 42Ah
Charge controller*	SPB-20 Bluetooth connection by smartphone or PC. MPPT high efficiency (> 95%)
Street lamp	Sun Light Western CO. Available models: 30W 4209lm
Color temperature – CRI	4000°K – CRI>70
Optic	Asymmetric for street and wide area lighting, suitable for ME Class as UNI11248 and UNI13201-2 . PMMA material protected by flat glass
Light control	Self-management flux reduction to maximize lamp operation during cloudy days.
Mechanical parts	Pole: 5mt high above the ground, steel made and hot deep galvanized and painted RAL 7043 . Wind load resistance in accordance to Eurocode 0-1-3 . and production compliant to EN1090-2 .

*on demand may be supplied **SPB-20/GSM** charge controller with **2G** modem with data monitoring through Western CO. web application (**WCloud**).
**4,5 mt - 14 ft - 9.17 in

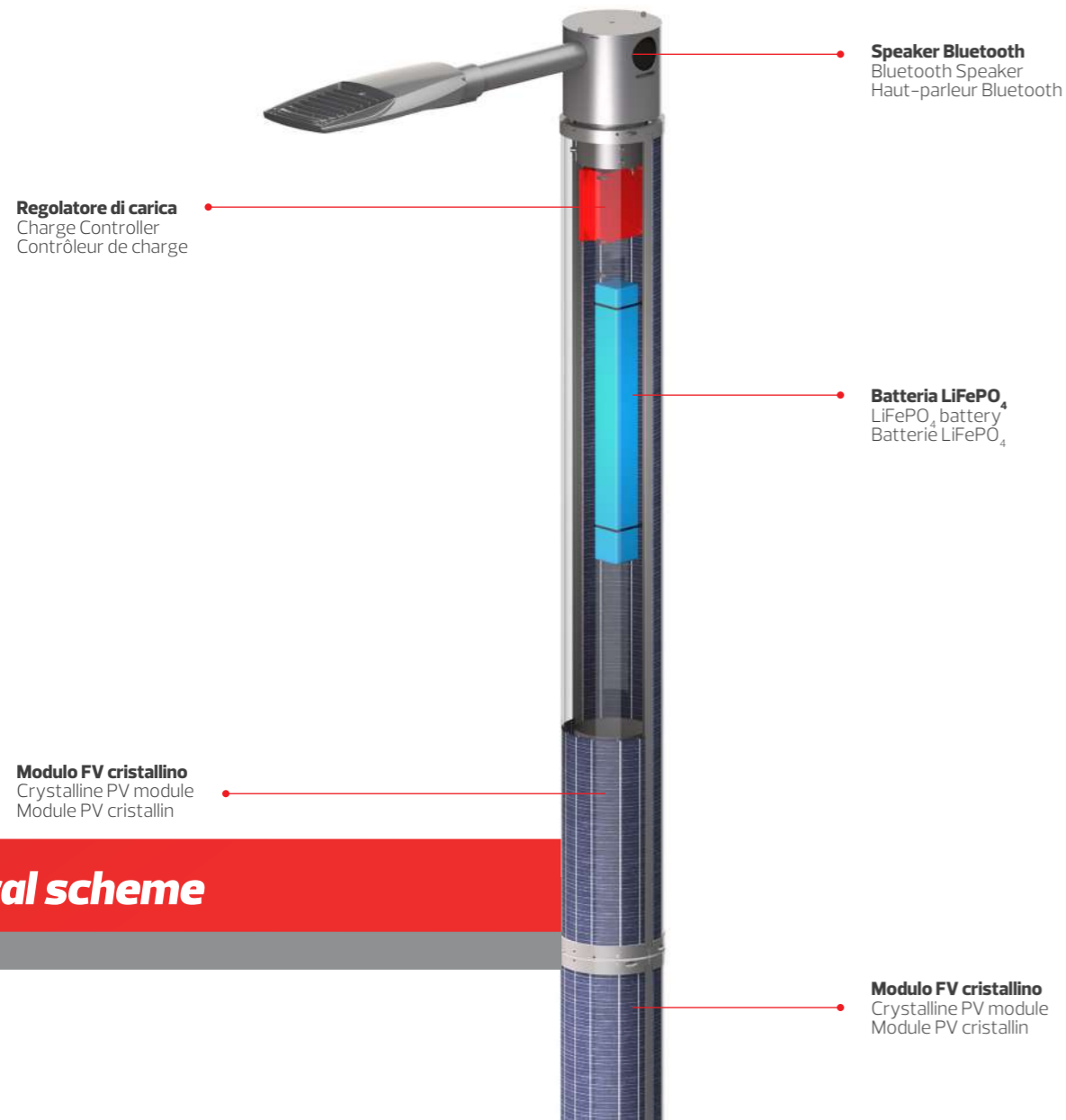

Technical scheme

Dimensioni del prodotto

[eng]
Product dimensions

[fra]
Dimensions du produit

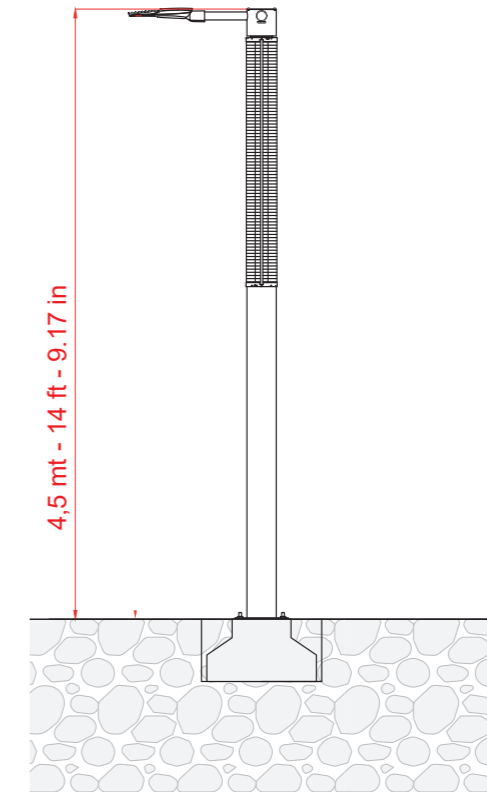

Realizzazioni

[eng]
Realizations

[fra]
Réalisations

